

Jsmea News

New ISO standards from Japan

SSAP's achievements to set ISO standards in autumn 2018

1. Introduction—what SSAP targets

To realize safe and efficient ship operations, it is important to produce outputs from application services that gather a large volume of sailing, engine, hull, meteorological, hydrographic and other data and organically combine and use these data. Currently, however, it is not easy to develop such mechanisms due to barriers that stand between different manufacturers, systems and devices, and the large amount of labor and costs.



Japan Ship Machinery and Equipment Association (JSMEA) has been proceeding with technological development, running the Ship Smart Application Platform (SSAP) under its umbrella. The SSAP consists of JSMEA members; shipping, shipbuilding and ICT companies; and a classification society. Assuming information integration with related systems of other fields of business, the SSAP has developed on-board and ship-to-shore information infrastructure to realize information sharing between on-board devices/systems and various application services. By testing various prototypes on board vessels actually operated, it has made clear specifications and performances required of them and raised their completion levels. Based on achievements that it has made through its activities, in addition, it has striven to set international standards for systems that a ship can share information when at sea.

CONTENTS

New ISO standards from Japan	1-3
JSMEA takes part in Sea Japan 2018	4-7
JSMEA makes presence at OTC 2018	8-9
JSMEA attends Posidonia 2018	10-12
Information on JSMEA members	13-22
AKASAKA DIESELS LIMITED	
DAIHATSU DIESEL MFG. CO., LTD.	
FURUNO ELECTRIC CO., LTD.	
HISAKA WORKS, LTD.	
Kyokuyo Electric Co., Ltd.	
Mitsui E&S Machinery Co., Ltd.	
SKK Corporation	
Mitsubishi Heavy Industries Marine Machinery & Equipment Co., Ltd.	
Turbo Systems United Co., Ltd.	
VOLCANO CO., LTD.	
JSMEA seminar schedule in FY2018	23
SMM Japan Pavilion	24

2. Outline of SSAP

2.1 Purposes of research

The on-board and on-shore application services listed below that use data from navigational instruments, engines and other ship machinery and equipment have become gradually popular in recent years.

- i) Weather routing;
- ii) Optimum trim;
- iii) Performance monitoring;
- iv) Engine monitoring; and
- v) Remote maintenance

The concept of smart navigation systems is to realize safe and efficient ship operations by making use of these application services. To this end, the SSAP provides support to make it easier for application services to access data from on-board devices so that many services will be available.

To make effective use of measured data and event data from on-board devices, it is important for navigation, engine, hull and other data to be time-synchronized, collectively managed and accessed.

The SSAP has commodified data that are time-synchronized by on-board and on-shore data servers, and

even allowed access to them by standardizing data when necessary.

By standardizing data shared by data servers, application program interfaces (APIs) between ship machinery and equipment and data servers, and APIs between application services and systems, it will be easier to provide application services and reduce costs for developing interfaces.

2.2 Outline of SSAP

The SSAP has carried out activities in two phases.

	SSAP	SSAP2
Term	Dec 2012 - Mar 2015	Aug 2015 - Sep 2018
Participants (organizations)	Members: 27 Observers: 9	Members: 38 Observers: 10
Joint Industry Project(JIP)	JSMEA + ClassNK	
Achievements	1. Design specification of shipboard data server 2. Implementation of shipboard data server and trial 3. Ship-shore open platform design for ship IOT 4. Proposed 2 ISO NPs (ISO NP19847 / ISO NP19848)	1. Marketing & promotion of the open platform concept 2. System design and prototyping of open platform 3. Standardization – ISO/FDIS 19847 / ISO/FDIS 19848 4. Development of Data catalogue 5. Public relations

3. From R&D projects to business development

The SSAP has been advancing technological development and international standardization so that data from ship machinery, equipment and systems will be used in various application services.

Using international standards will provide advantages to business operators that want to use data, including ship owners and shipbuilders. For example, costs can be reduced for collecting data from ships by adopting standardized technologies, and it will be possible to choose optimum application programs.

Meanwhile, using data will enable not only ship operators, but also shipyards, manufacturers, non-life insurers, ship owners, port-state-control (PSC) authorities, researchers and classification societies, to make innovations for improving ship safety and performance. As a project to maximize advantages by making the entire maritime cluster use data, Ship Data Center Co., Ltd. (ShipDC), a wholly owned subsidiary of Nippon Kaiji Kyokai (ClassNK), set up an Internet of Ships Open Platform (IoS-OP) in May 2018. The platform has created a dictionary of data that comply with ISO/FDIS 19848, an achievement made by the SSAP, and launched a service for standardizing different data names for existing vessels and provide them to users. As a service

for application service providers, the SSAP is advancing the development of a test bed to allow on-board servers complying with ISO/FDIS 19847, another achievement made by the platform, to collect data from ship machinery and equipment, to transmit them to the overland data center, ShipDC, via communication satellites, and to make connection tests through APIs.

4. Future activities

The ongoing SSAP2 is scheduled to end in September 2018. As such, JSMEA intends to set up a new group to study the proposals listed below that Japan has made in respect to smart shipping.

- i) Standardizing test methods of ISO/FDIS 19847;
- ii) Revision of ISO 16425;
- iii) Testing & inspection methods of ISO 16425;
- iv) Enhancing cyber security of ISO/FDIS 19847; and
- v) Ship-shore data communication

JSMEA will continue to make international contributions by making the most of Japan's regional characteristics, where one of the greatest shipping, shipbuilding, ship machinery and equipment industries in the world, as well as one of the world's largest classification societies huddle together, and by promoting efforts to ensure ship safety and protect the natural environment at sea.

Standardized shipboard data server

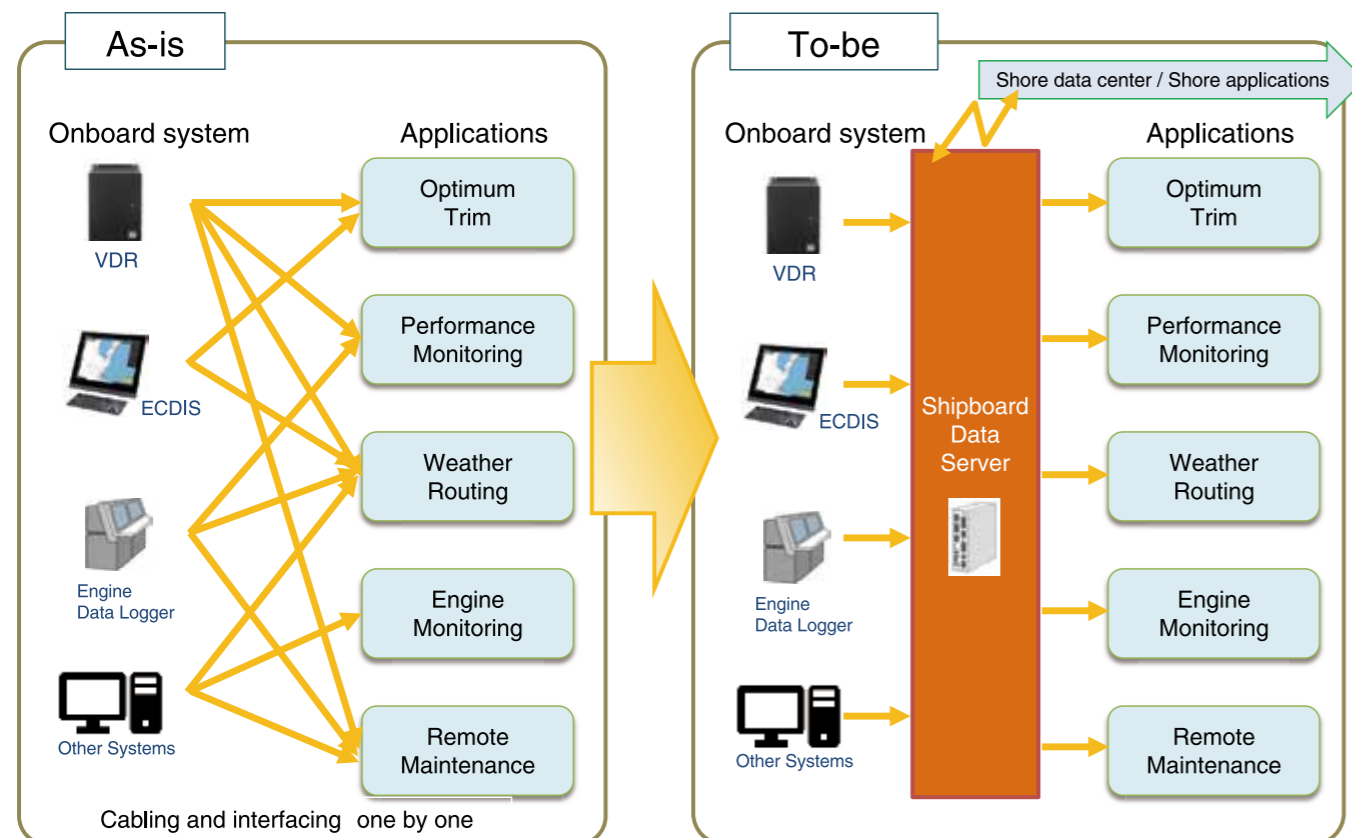

Open platform for maritime industry

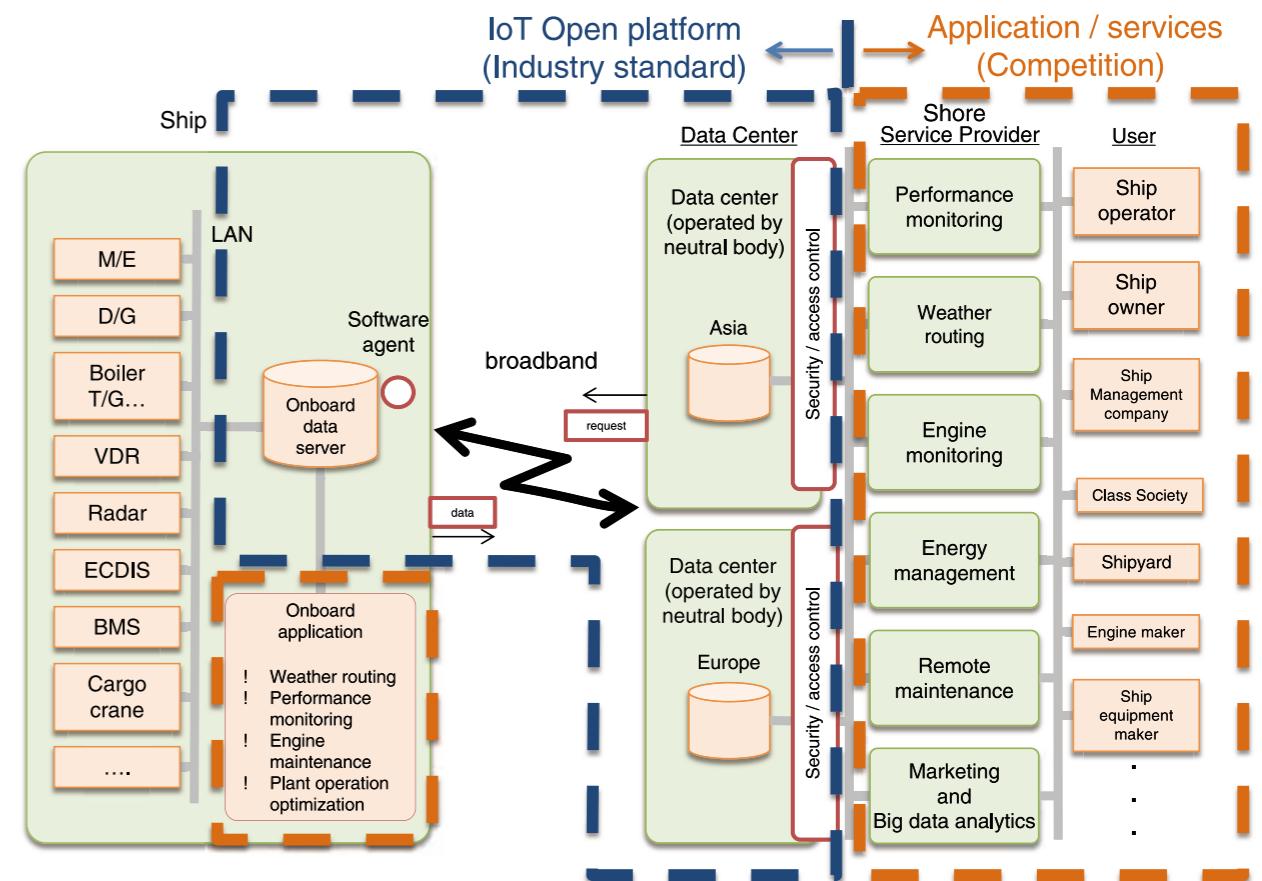

JSMEA takes part in Sea Japan 2018

Japan Ship Machinery and Equipment Association (JSMEA) participated in Sea Japan 2018 with financial support from The Nippon Foundation and other assistance from the Ministry of Land, Infrastructure, Transport and Tourism (MLIT) and other relevant organizations. At the 13th international exhibition, it ran the Japan Maritime Industry Cluster Pavilion to exhibit products, services, technologies and so on, and give events.

According to a preliminary announcement by the organizer, Sea Japan 2018 hosted a total of 580 exhibitors from Japan and overseas, and welcomed 20,226 visitors, more than at Sea Japan 2017.

Like last year, the MLIT and other governmental organizations as well as relevant private organizations and enterprises had set up a Japan Maritime Cluster Committee, which was overseen by Mr. Takemasa Minemoto, director, Boat Affairs Office, Shipbuilding and Ship Machinery Division, Maritime Bureau, MLIT. Activities included maritime cluster exhibitions; international maritime affairs, ship technology and marine engineering seminars; events for students and a field trip on board the Yokosuka, a support vessel for deep-sea surveys, and the Shinkai 6500, a deep submergence research vehicle, both of which are owned by the Japan Agency for Marine-Earth Science and Technology (JAMSTEC).

At the commencement ceremony on Day 1, Mr. Shinichiro Otsubo, senior deputy director-general of MLIT's Maritime Bureau, gave the opening speech, conveying a message from Prime Minister Shinzo Abe. After his address, industry heavyweights joined in the ribbon-cutting ceremony.

At the International Maritime Seminar, held immediately

after the opening ceremony, Mr. Mitsuyuki Unno, executive director of The Nippon Foundation, and Mr. Daniel Bjarmann-Simonsen, state secretary of trade and industry of Norway, gave keynote speeches in Session 1. In Session 2, a Southeast Asia Maritime Summit was held for the first time. Moderated by Mr. Hiroaki Sakashita, advisor of Nippon Hakuyohin Kentei Kyokai, a panel discussion was joined by Mr. Masaharu Ono, vice-chairman of JSMEA; Mr. Otsubo and representatives from Southeast Asian ship owners associations. The panelists exchanged views on future cooperation between Japan and Southeast Asia. The seminar was attended by about 500 people.

In the evening of April 11, JSMEA and the MLIT co-hosted an International Maritime Seminar Reception at the Grand Nikko Tokyo Daiba, at which Mr. Katsunori Takahashi, MLIT parliamentary vice-minister, was a guest speaker. A total of 80 individuals—including employees of JSMEA-affiliated ship machinery and equipment manufacturers, and those of other compatriot parties concerned with maritime affairs—held dialogues with Mr. Simonsen and other speakers from the Southeast Asia Maritime Summit.

Under the catchphrase: "Green Innovation & Digitalization—Japan: Leading the Way to the Future," exhibition spaces were created in the Thematic Zone of the Japan Pavilion for environmental technologies, offshore development and the Internet of Things (IoT), among others.

Marine resource exploitation-related exhibitions saw the return of JAMSTEC, Japan Oil, Gas and Metals National Corporation (JOGMEC), INPEX Corporation,

Japan Drilling Co., Ltd. (JDC) and others that were present at the last Sea Japan exhibition. As for domestic ferries, a new subject in 2018, eight member operators of the Japan Long Course Ferry Service Association (JLCFSA) displayed models of cutting-edge ferries. They also offered a virtual reality (VR) experience program so that visitors were allowed to virtually board a ferry newbuilding to be deployed soon.

In the Members Zone, meanwhile, 73 JSMEA members participated, the highest number ever, to showcase their respective products, services and so on.

Sea Japan 2018 welcomed VIPs including Mr. Tsukasa Akimoto, MLIT state minister, and Mr. Mitsuyuki Unno, executive director of The Nippon Foundation, along with so many more guests from Japan and other economies to lead many of the Japan Pavilion members to claim that this year's exhibition was more successful than Sea Japan 2017.

On Day 2 (April 12), Mr. Shinzo Yamada, chairman of JSMEA, spoke at the Sea Japan 2018 International Conference. The speech was heard by some 400 people, according to Kaiji Press Co., Ltd., the organizer of the meeting.

On the afternoon of the second and third days, several events were geared for invited students—nearly 80—from universities and colleges across the country. Mr. Yasuo Tanaka, president of Monohakobi Technology Institute Co., Ltd. (MTI), Mr. Masato Oda, CEO and president of Uzushio Electric Co., Ltd. and other industry stakeholders gave presentations to the attendees, who were given opportunities to meet with former employees of JSMEA affiliated manufacturers, go on a field trip on board JAMSTEC research vessels and participate in a guided tour of the exhibitions. These programs allowed JSMEA to help the students better understand the industry.

Also on April 12, JSMEA welcomed individuals from Iceland's maritime industry and affairs—who were attending Sea Japan for the first time—to meet with members of JSMEA's Overseas Fishing Vessel Market Development Working Group. Icelandic enterprises

introduced their respective business activities, while staff members from the Nordic nation's embassy in Tokyo were also present. The parties exchanged information on their countries' fishing industries and vessels.

On the final day (April 13), JSMEA organized a Ships and Marine Technology Seminar together with the MLIT and Nippon Kaiji Kyokai (ClassNK). Members of the association's Smart Ship Application Platform 2 Project (SSAP2) gave briefings on an outline of the proposal for a new ISO standard in the works along with other subjects.

JSMEA also did something new at Sea Japan 2018. With help from JAMSTEC, it opened to the public, the Yokosuka and Shinkai 6500. A total of 1,430 visitors were provided the opportunity to see firsthand by going on board these vessels constructed with Japanese technologies.

On April 12 and 13, JSMEA organized its annual meetings to boost exchanges between its executives and members companies and those from the Korea Marine Equipment Association (KOMEA).

Sea Japan 2018 was reported on April 12 in TV Asahi Corporation's news programs.

1) Outline of Sea Japan 2018

Dates: Wednesday-Friday April 11-13, 2018

Venue: Tokyo International Exhibition Center (east halls 5 and 6, Tokyo Big Sight)

Organizer: UBM Japan Co., Ltd.

Number of visitors: 20,226 (according to preliminary figures released by the organizer)

Number of exhibitors: 580 (according to the organizer)

2) Outline of the Thematic Zone (financially supported by The Nippon Foundation)

To show off the technological capabilities of the Japanese maritime cluster both domestically and internationally, the Sea Japan 2018 Japan Maritime Cluster Committee—consisting of the MLIT, relevant organizations, universities and colleges, shipping companies and others—mounted comprehensive



Mr. Shinichiro Otsubo gives the opening speech at Sea Japan 2018.



The ribbon-cutting ceremony is conducted.



International Maritime Seminar Reception



Japan Pavilion



Mr. Mitsuyuki Unno gives a keynote speech at the International Maritime Seminar.



International Maritime Seminar



Southeast Asia Maritime Summit



Mr. Shinzo Yamada delivers a speech at the Sea Japan 2018 International Conference.



Thematic Zone

showings of the products, technologies and other features studied and/or developed in Japan.

A) Area of exhibitions: 750 square meters (in the Japan Pavilion)

B) Theme: “Green Innovation & Digitalization—Japan: Leading the Way to the Future”

C) Methods of exhibitions: Spaces were allotted for subjects such as shipping, environmental technologies, marine development, the IoT and others, where models, panels, images and other materials were displayed. Marine resource development-related exhibitions were provided by JAMSTEC, JOGMEC, INPEX, JDC and other parties that had also participated in Sea Japan 2017. In the domestic ferry business—new to the event from this year—eight members of the JLCFSA participated.

3) Outline of seminars (financially supported by The Nippon Foundation)

International Maritime Seminar/Southeast Asia Maritime Summit

A) Time/dates: 10:00-12:30, Wednesday, April 11

B) Venue: 6th floor, Conference Tower, Tokyo Big Sight

C) Host: Sea Japan 2018 Japan Maritime Cluster Committee

D) Details—a) The MLIT, The Japan Foundation and the Ministry of Trade, Industry and Fisheries of Norway delivered keynote speeches. b) As the Southeast Asia Maritime Summit, a panel discussion was presented, with Mr. Otsubo, Mr. Ono and representatives from the ship owners associations in five newly industrialized economies in Asia (Indonesia, Malaysia, the Philippines, Singapore and Thailand).

E) Number of attendees: approximately 500 (according to the organizer)

Ships and Marine Technology Seminar

A) Time/dates: 10:30-16:30, Friday, April 13

B) Venue: Seminar Room C, East Hall 6, Tokyo Big Sight Exhibition Center

C) Co-hosts: JSMEA, the MLIT and ClassNK

D) Details: Developments in environmental technologies, IT and other topics were introduced. JSMEA unveiled achievements made by its SSAP2.

4) Outline of events for students (financially supported by The Nippon Foundation)

A) Time/dates: Thursday-Friday, April 12-13

B) Locations: Sea Japan 2018 venue

C) Details: JSMEA invited 77 students that it had built relations with through ship machinery and equipment seminars and other events held. The students were encouraged to visit exhibitions, attend lectures by specialists in maritime affairs, go on a field trip on board JAMSTEC research vessels and meet with alumnae and alumni of their respective universities and colleges who now work for JSMEA member companies.

D) Lectures on the present and future of the Japanese maritime industry, including the ship machinery and equipment industry

i) Time/dates: 13:15-14:45, Thursday, April 12

ii) Venue: Conference Room 101, 1st floor, Conference Tower, Tokyo Big Sight

iii) Lecturers: Mr. Yasuo Tanaka, president, MTI; Mr. Masato Oda, CEO/president, Uzushio Electric; Mr. Denis Ruban, Development Division, Power Solution Business, Yanmar Co., Ltd. and Ms. Naomi Fujisawa, head, Navigation System Laboratory, Research Department, Research and Innovation Center, Furuno Electric Co., Ltd.

5) Opening of JAMSTEC vessels to the general public (financially supported by The Nippon Foundation and cooperated by JAMSTEC)

A) Time/date: 10:00-16:00, Friday, April 13

B) Location: Passenger ship terminal in front of Tokyo Big Sight

C) Details: JAMSTEC’s support vessel for deep-sea surveys, the Yokosuka, and manned submergence research vehicle, the Shinkai 6500, were opened to the general public.

D) Number of participants: 1,430

6) Outline of the Members Zone (set up by JSMEA)

A) Number of attending JSMEA members: 73 (record)

*Number of exhibitors from JSMEA at Sea Japan 2017: 65

B) Total area of exhibitions: 1,548 square meters (record)

<Exhibitors>: Akasaka Diesels Ltd.; Azbil Corporation; The China & Japan Marine Industries Ltd.; Chugoku Marine Paints, Ltd.; Conhira Co., Ltd.; Daido Steel Co., Ltd.; Daihatsu Diesel Mfg. Co., Ltd.; Daikin MR Engineering, Ltd.; Eco Marine Power Co., Ltd.; EIZO Corporation; Fuji Electric Co., Ltd.; Fuji Trading Co., Ltd.; Furukawa Electric Industrial Cable Co., Ltd.; Geislinger K.K.; Hien Electric Industries, Ltd.; Hitachi Nico Transmission Co., Ltd.; HSN-Kikai Kogyo Co., Ltd.; Ibuki Kogyo Co., Ltd.; Japan Engine Corporation; Japan Weather Association; Japan Radio Co., Ltd.; JFE Engineering Corporation; JRCS Mfg. Co., Ltd.; Kanagawa Kiki Kogyo Co., Ltd.; Kawasaki Heavy Industries, Ltd.; KEI System Co., Ltd.; Kokosha Co., Ltd.; Kurita Water Industries Ltd.; Kyokuyo Electric Co., Ltd.; Mabane Zoki Co., Ltd.; Matsui Corporation; Mitsubishi Heavy Industries Marine Machinery & Equipment Co., Ltd.; Mitsui Engineering & Shipbuilding Co., Ltd.; Mizuno Marine Co., Ltd.; Murayama Denki Ltd.; Musashino Co., Ltd.; Nabtesco Corporation; Nakashima Propeller Co., Ltd.; Naniwa Pump Mfg. Co., Ltd.; Niigata Power Systems Co., Ltd.; Nippon Hakuyo Electronics, Ltd.; Nippon Paint Marine Coatings Co., Ltd.; Nishishiba Electric Co., Ltd.; N.Y. Co., Ltd.; NYK Trading Corporation; Okamura Engineering Corporation; Sasakura Engineering Co., Ltd.; Satake Corporation; Sekigahara Seisakusho Ltd.; Shimada & Co., Ltd.; Shinko Ind. Ltd.; Shonan Co., Ltd.; Suction Gas Engine Mfg. Co., Ltd.; Taiko Kikai Industries Co., Ltd.; Taiko Sangyo Co., Ltd.; Taiyo Electric Co., Ltd.; Tanaba Pneumatic Machinery Co., Ltd.; Techno Kashiwa Corporation; Teikoku Machinery Works, Ltd.; Terasaki Electric Co., Ltd.; Tokyo Keiki Inc.; Tokyo Nissin Jabara Co., Ltd.; Tobu Jukogyo Co., Ltd.; Ushio Reinetsu

Co., Ltd.; Utsuki Keiki Co., Ltd.; Uzushio Electric Co., Ltd.; Volcano Co., Ltd.; Wakefield Corporation; Woods Corporation; Yamashita Seiki Co., Ltd.; Yamato Metal Co., Ltd.; Yanmar Co., Ltd. and Yokogawa Denshikiki Co., Ltd.

7) Others

International Maritime Seminar Reception

Time/date: 18:00-20:00, Wednesday, April 11

Venue: Banquet Room Ginga, 29th floor, Grand Nikko Tokyo Daiba

Number of attendees: approximately 80

Meeting of JSMEA’s Overseas Fishing Market Development Working Group and enterprises from Iceland

Time/date: 12:30-14:00, Thursday, April 12

Venue: East Hall 6, Tokyo Big Sight

Number of attendees from Japan: 25 (members of the abovementioned working group)

Number of attendees from Iceland: 8 (from the Embassy of Iceland, shipping companies and makers of containers for fishing boats and fiber ropes)

Speech by JSMEA Chairman Yamada

Time/date: 14:40-15:30, Thursday, April 12

Venue: 6th floor, Conference Tower, Tokyo Big Sight

Number of attendees: approximately 400 (according to the organizer)

13th meeting of JSMEA and KOMEA

Time/date: 19:00-21:00, Thursday, April 12

Venue: Hilton Tokyo Odaiba

Number of attendees: 13 (from JSMEA: 8—Mr. Yamada; Mr. Shigeki Kinoshita; Mr. Ono; Mr. Yukio Furuno, vice-chairman; Mr. Kazuhiko Kinoshita; Mr. Katsuhiko Fujiwara, vice-chairman; Mr. Shoichi Kitamura, executive managing director and Mr. Noboru Ando, managing director) and (from KOMEA: 5—Mr. Park Yoon-so, chairman; Mr. Goo Ja-young; Mr. Yang Ho-chan; Mr. Kang Jae-jong and Mr. Chung Chang-soo)



Mr. Tsukasa Akimoto (left) visits the Japan Pavilion.

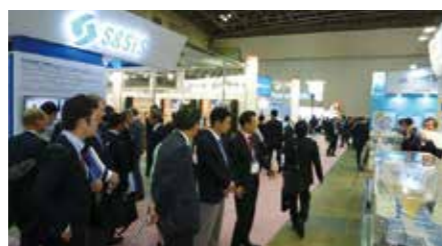

Mr. Mitsuyuki Unno (third from left) view exhibits at the Japan Pavilion.



JAMSTEC's Yokosuka is opened to the general public.



Mr. Yasuo Tanaka gives a presentation to students.



Students meet with JSMEA member companies.

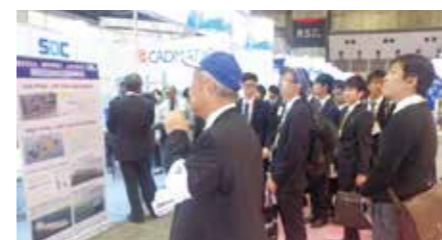

Students go on a tour of the Japan Pavilion.



The 13th meeting is convened between JSMEA and KOMEA.



Ships and Marine Technology Seminar



JSMEA holds a meeting with enterprises from Iceland.

JSMEA makes presence at OTC 2018

Japan Ship Machinery and Equipment Association (JSMEA) attended the 2018 Offshore Technology Conference (OTC) in Houston, Texas on April 30-May 3 as a project financially supported by The Nippon Foundation. Celebrating its 50th anniversary in 2018, OTC is the world's largest international conference and exhibition organized for the offshore development business. This was JSMEA's sixth time attending OTC since 2013.

From JSMEA, Mr. Shinzo Yamada, chairman; Mr. Masaharu Ono and Mr. Shigeki Kinoshita, vice-chairmen; and Mr. Shigeharu Oda, leader of the Offshore Development Strategy Review Board, took 11 of its affiliated companies to OTC. JSMEA members were joined again by their regular partners: INPEX Corporation; the Japan Agency for Marine-Earth Science and Technology (JAMSTEC); Japan Drilling Co. Ltd. (JDC); Japan Oil, Gas and Metals National Corporation (JOGMEC); and Nippon Kaiji Kyokai (ClassNK). Including a new member, JX Nippon Oil and Gas Exploration Corporation, the delegation of 17 enterprises and organizations erected the Japan Pavilion where it conducted sales and marketing activities together with compatriot upstream enterprises and other parties engaged in offshore development.

OTC 2018 welcomed a total of 61,300 visitors. Although the number was smaller than last year, when 64,700 people came to the conference, more than 2,300 exhibitors from 44 countries created a much brighter, vibrant atmosphere in the venue, taking advantage of recent recoveries in oil prices.

When a survey was conducted among exhibitors at the Japan Pavilion, all answered they had more visitors and business negotiations than they had at OTC 2017.

On April 30, or Day 1 of OTC 2018, 73 representatives from

exhibitors, organizations and other members of the Japan Pavilion met for a networking event and rally. During the event, JX Nippon Oil and Gas Exploration gave a seminar on offshore development projects, while the attendees were active in exchanging information.

On May 1, a ceremony was held by The Nippon Foundation at the Hotel Zaza to sign a memorandum of understanding (MoU) on the establishment of an international cooperation program for the development of marine energy (petroleum and natural gas). To build relations with offshore developers and relevant parties from other economies, JSMEA organized a lunch reception—with financial assistance from the foundation—that was joined by some 110 individuals.

In the evening of the same day, JSMEA organized a networking reception at Minute Maid Park, at which approximately 200 people from the offshore development industry mingled and deepened relationships. As the association held a reception at the ballpark, the home field of the Houston Astros, for three consecutive years, the Major League baseball team told it to throw out a first pitch before a home game. Mr. Yohei Sasakawa, chairman of The Nippon Foundation, threw the first pitch at the game played on the day with the New York Yankees, on behalf of the JSMEA delegation.

On May 4, JSMEA held a get-together with some 20 individuals from Japanese ship owners doing business in Houston and other parties.

During OTC 2018, bookings were accepted for space at OTC 2019. JSMEA reserved a 300-square-foot (approximately 28-square-meter) space at NRG Center, where the United Kingdom, Norway, the Netherlands and other major offshore developer nations will gather for national pavilions. Now, it intends to host two

Japan pavilions next year: one in the space at NRG Center and one (approximately 300 square meters) at NRG Arena. This year, the Japan Pavilion was only located at the arena.

JSMEA's Offshore Development Strategy Review Board, which has the Mobile Units and Support Vessel working groups under its umbrella, will continue to evaluate the current fiscal activities of the association and discuss how it will use the spaces in the main hall at OTC 2019.

Concurrent events JSMEA took part in while attending OTC 2018:

April 27: (1) JSMEA visited INPEX's Houston Office to express its gratitude for assisting with its activities and garner information on recent oil and gas development and relevant issues. (2) JSMEA also called at the Japan External Trade Organization (JETRO) Houston to gather data on economic conditions and other local affairs.

April 30: (1) JSMEA held a networking event and rally to meet with exhibitors, organizations and other members of the Japan Pavilion (including upstream enterprises and other parties engaged in offshore development). Seventy-three representatives exchanged information and views with each other. (2) During that event, JSMEA asked JX Nippon Oil and Gas Exploration to give a seminar on offshore development projects.

May 1: (1) The Nippon Foundation organized a ceremony for signing an MoU for the founding of an international cooperation framework to develop marine energy (petroleum and natural gas). After the ceremony, JSMEA held a lunch reception with financial support from the foundation to meet with parties from other countries engaged in offshore development. The reception was attended by some 110 individuals. (2) JSMEA gave a networking reception at Minute Maid Park, hosting approximately 200 people from the offshore development industry. Mr. Yohei Sasakawa, chairman of The Nippon Foundation, threw the ceremonial first pitch, having accepted an invitation from the MLB club Houston Astros

May 3: Mr. Ono, Mr. Kinoshita and other JSMEA executives visited MODEC International, Inc. to obtain information on recent oil and gas projects and related developments.

May 4: (1) JSMEA held a get-together to boost exchanges with employees of Houston-based Japanese ship owners, which was attended by some 20 people. (2) JSMEA had a business meeting with Chevron Corporation, at which five member companies introduced their respective products. (3) JSMEA took part in an event organized by the government of Malaysia, entitled "The Malaysian Oil and Gas Landscape—Industry Outlook and Opportunities"

Outline of OTC 2018

Official title: Offshore Technology Conference 2018

Days: Monday-Thursday, April 30-May 3, 2018

Venue: NRG Park

Japan Pavilion: booth Nos. 7045, 7053 and 7145

Outline of Japan Pavilion

Days: Monday-Thursday, April 30-May 3, 2018

Venue: NRG Park

Booth Nos.: 7045, 7053 and 7145

Member companies/organizations (alphabetical order):

Daido Steel Co., Ltd.; Daihatsu Diesel Mfg. Co., Ltd.; Fuji Trading Co., Ltd.; Hien Electric Industries, Ltd.; INPEX Corporation; Japan Agency for Marine-Earth Science and Technology (JAMSTEC); Japan Drilling Co. Ltd. (JDC); Japan Oil, Gas and Metals National Corporation (JOGMEC); JX Nippon Oil and Gas Exploration Corporation; Maekawa Mfg. Co., Ltd.; Nippon Kaiji Kyokai (ClassNK); Nippon Paint Marine Coatings Co., Ltd.; Shinko Ind. Ltd.; Teikoku Machinery Works, Ltd.; Tokyo Rope Mfg. Co., Ltd.; Ushio Reinetsu Co., Ltd. and Yanmar Co., Ltd.

Supporters:

Ministries of Economy, Trade and Industry (METI) and Land, Infrastructure, Transport and Tourism (MLIT)



JSMEA visits INPEX's Houston Office.



Japan Pavilion exhibitors co-host a networking reception.



JSMEA visits MODEC International.



An event held by the government of Malaysia

Booths at Japan Pavilion

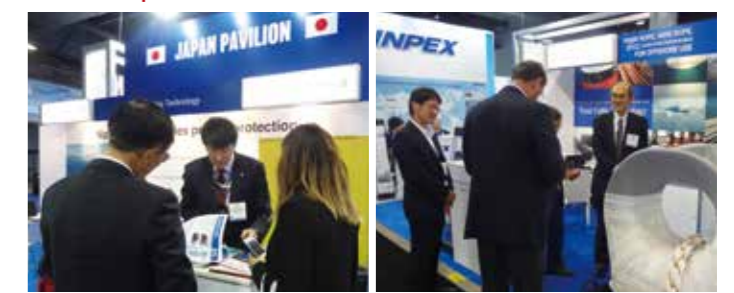

JX Nippon Oil and Gas Exploration gives a seminar.



Members from Japan Pavilion exhibitors introduce themselves.

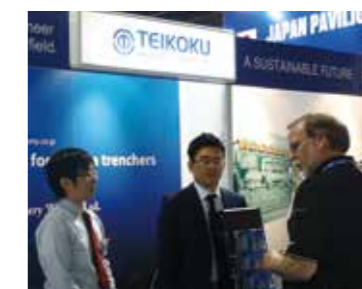

JSMEA attends Posidonia 2018

Japan Ship Machinery and Equipment Association (JSMEA) was present at Posidonia 2018, an international shipping exhibition held in Athens, Greece on the week of June 4-8, 2018. With financial support from The Nippon Foundation, it hosted the Japan Pavilion together with the Japan Ship Exporters' Association (JSEA) and Nippon Kaiji Kyokai (ClassNK). Joined by 14 member companies, the JSMEA delegation was led by Mr. Shinzo Yamada, chairman; Mr. Masaharu Ono, vice-chairman and head of the Global Business Strategy Review Board; and vice-chairmen Mr. Shigeki Kinoshita, vice-chairman and Mr. Katsuhiko, Fujiwara.

according to the event's organizers—many of whom from Greek ship owners and other parties from the European maritime industry crowded into the Japan Pavilion, which was located near Entrance 1. As the shipping and shipbuilding markets were both more brisk than when Posidonia was last organized two years ago, the venue's atmosphere was much livelier as well, being filled with more people.

On Day 1, the ribbon-cutting at the Japan Pavilion was conducted by Mr. Yamada; Mr. Yasuhiro Shimizu, Japanese ambassador to Greece; Mr. Shigeru Murayama, president of the JSEA; Mr. Koichi Fujiwara, chairman and president of ClassNK and Mr. Yasuhiko Kato, chairman of

Posidonia 2018 welcomed some 22,000 visitors—

The Shipbuilders' Association of Japan (SAJ). Meanwhile, the official opening ceremony for Posidonia 2018 was attended by Greek Prime Minister Alexis Tsipras.

On Day 2, JSMEA organized a seminar with the JSEA, entitled "Maritime Innovations—New Development in Environmental Conservation and Technology." The seminar accommodated more than 170 attendees, including those from local ship owners. During the first session, seven JSMEA members and three compatriot shipbuilders introduced their respective products for saving energy and/or protecting the natural environment. A panel discussion was held during the second session, at which Mr. Fujiwara exchanged views on recent newbuilding market developments and environmental efforts with representatives from the Ministry of Land, Infrastructure, Transport and Tourism (MLIT) of Japan, ClassNK and the Union of Greek Shipowners (UGS), among other organizations.

On Day 3, 30 students learning about the maritime industry at the National Technical University of Ukraine visited the Japan Pavilion. JSMEA gave them briefings on today's Japanese ship machinery and equipment industry and actions to be taken in the future. After hearing the briefings, the students visited members' booths.

On Day 4, Mr. Ono took six JSMEA member companies to the UGS. Providing information on up-to-date developments on their respective products and services, they made interchanges and enthusiastically exchanged opinions with Greek shipowners. Highly rating the quality of Japanese ship machinery and equipment as well as relevant services, local ship owners requested that worldwide networks be further upgraded. As Greek ship owners have long been important customers for the Japanese ship machinery and equipment industry, JSMEA indicated that it will continue to exchange views with the UGS.

JSMEA pays courtesy call at Japanese ambassador to Greece



Mr. Katsuhiko Fujiwara (far left); Mr. Shigeki Kinoshita (second from left); Mr. Yasuhiro Shimizu (third from left); Mr. Shinzo Yamada (center); Mr. Masaharu Ono (third from right); and Mr. Noboru Ando, managing director, JSMEA

Japan Pavilion



Ribbon-cutting ceremony at Japan Pavilion



From left: Mr. Yasuhiko Kato, Mr. Shigeru Murayama, Mr. Yasuhiro Shimizu, Mr. Shinzo Yamada and Mr. Koichi Fujiwara

Mr. Noboru Ando gives a briefing at the Japan Pavilion to students from the National Technical University of Ukraine.



Exhibitors at/visitors to Posidonia 2018

Number of exhibitors: over 2,011 (from 92 countries and regions)
Number of visitors: approximately 22,000
Number of exhibitors from JSMEA: 14 (10 with booths: Azuma Kako Co., Ltd.; Daihatsu Diesel Mfg. Co., Ltd.; Fuji Electric Co., Ltd.; Fuji Trading Co., Ltd.; Japan Engine Corporation;

JFE Engineering Corporation; Mitsubishi Heavy Industries Marine Machinery & Equipment Co., Ltd.; MOL Techno-Trade, Ltd.; Yanmar Co., Ltd.; and Yokogawa Electric Corporation); (3 displaying information panels: Manabe Zoki Co., Ltd.; Shinko Ind. Ltd.; and Tobu Jukogyo Co., Ltd.) and (1 distributing catalogs: Chugoku Marine Paints, Ltd.)

JSMEA organizes seminar



JSMEA visits UGS

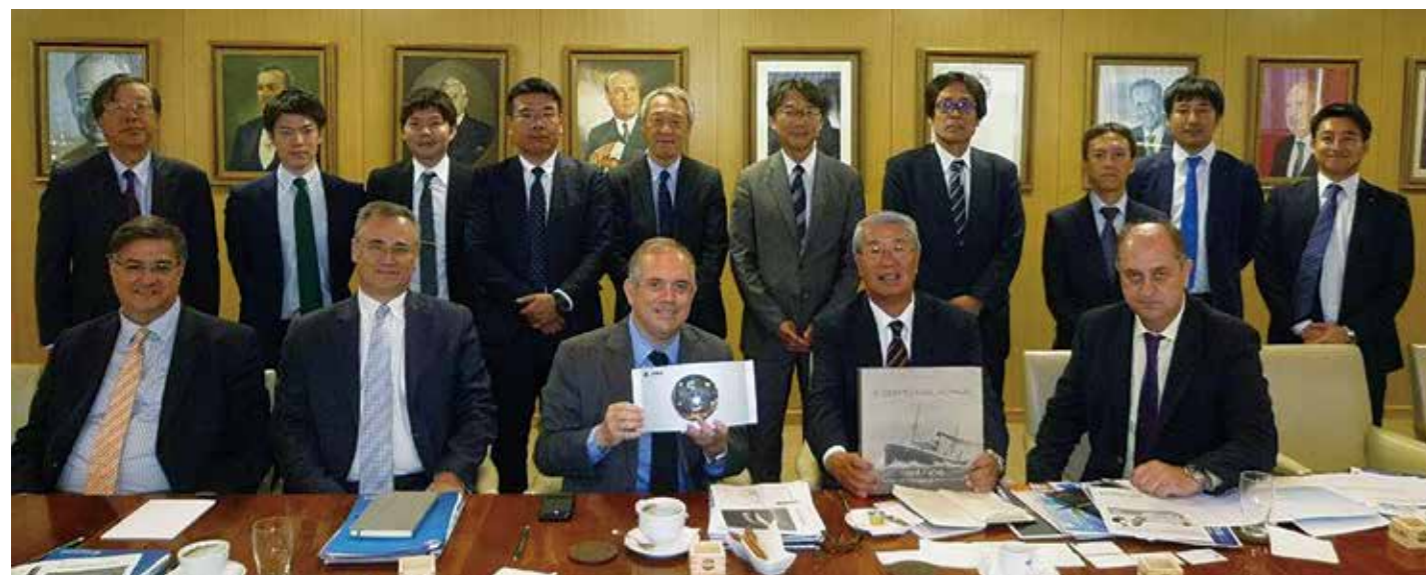

From JSMEA, Mr. Masaharu Ono, Mr. Noboru Ando and representatives from Daihatsu Diesel Mfg., Fuji Electric, Fuji Trading, Mitsubishi Heavy Industries Marine Machinery and Equipment, MOL Techno-Trade and Yanmar; and from UGS, a board of directors member Mr. Dimitrios Fafalios, Mr. Elias Sampatakakis, Mr. Ioannis Kourouniots and Mr. John Andreopoulos

Akasaka Diesels Limited

**High performance and compact UE Diesel Engine
 UEC33LSE-C2 and UEC35LSE-Eco-B2**

Overview

Akasaka Diesels Limited is one of the leading manufactures of main engine for ship propulsion in Japan. Akasaka has been producing own design low speed 4 stroke engine and 2 stroke UE engine designed by Japan Engine Corporation. (Hereinafter called "J-ENG")

The basic design for UEC35LSE-Eco-B2 (electronically controlled engine) was jointly developed by Winterthur Gas & Diesel and J-ENG. The electronically controlled potion for UEC35LSE-Eco-B2 was originally developed by J-ENG and UEC35LSE-Eco-B2 obtains the lowest fuel oil consumption in this class of the engines. UEC33LSE-C2 is mechanical type engine using the base design of UEC35LSE. Both type of engine have been adopted for many kind of small vessel, Bulk career, Chemical tanker, Asphalt tanker, LPG, Container, Cement carrier, Ferry and Ro-Ro.

The following are features of these engines.

UEC33LSE-C2

- Mechanical controlled engine
- Almost the same SFOC as other electronically controlled engine in this class.

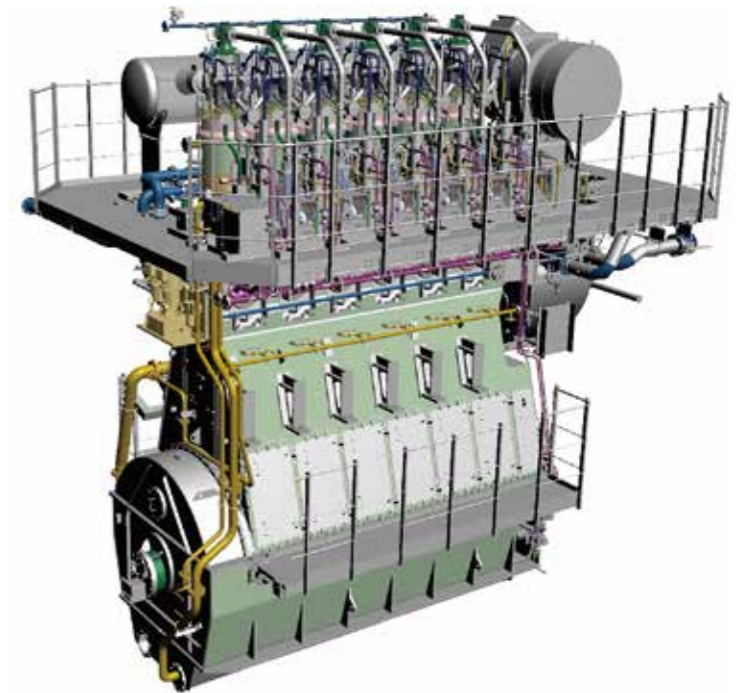

UEC35LSE-Eco-B2

- Electronically controlled engine (Eco engine)
- Lowest SFOC in this class.

UEC33LSE-C2					UEC35LSE-Eco-B2				
Main data					Main data				
Cylinder bore	330mm				Cylinder bore	350mm			
Piston stroke	1,550mm				Piston stroke	1,550mm			
Stroke/bore	4.70				Stroke/bore	4.43			
Rated Power: Propulsion engines					Rated Power: Propulsion engines				
Speed	167min ⁻¹		121min ⁻¹		Speed	167min ⁻¹		125min ⁻¹	
Piston Speed	8.6m/s		6.3m/s		Piston Speed	8.6m/s		6.3m/s	
Cyl.	P1	P2	P3	P4	Cyl.	P1	P2	P3	P4
	kW		kW			kW		kW	
5	4,150	3,325	3,000	2,400	5	4,350	3,475	3,250	2,600
6	4,980	3,990	3,600	2,880	6	5,220	4,170	3,900	3,120
7	5,810	4,655	4,200	3,360	7	6,090	4,865	4,550	3,640
8	6,640	5,320	4,800	3,840	8	6,960	5,560	5,200	4,160
Specific fuel oil consumption(SFOC)					Specific fuel oil consumption(SFOC)				
	P1	P2	P3	P4		P1	P2	P3	P4
SFOC(g/kWh)	174.0	170.0	173.9	169.9	SFOC(g/kWh)	167.0	161.0	166.9	161.0

Akasaka Diesels Limited

AKASAKA DIESELS LIMITED

14th Fl. South Tower, Yurakucho Denki Bldg, 1-7-1, Yurakucho, Chiyoda-ku, Tokyo 100-0006 Japan
 URL: <http://www.akasaka-diesel.jp/en/>
 Tel: +81-3-6860-9085 E-mail: kaigaieigyou@akasaka.co.jp

DAIHATSU

New Product 8DEL-23

A long-stroke version of the eco-friendly DE-23 debuts, saving space with greater power and low fuel consumption.

With the installation of environmental devices and the increase in electronic equipment, onboard power consumption has been rising in recent years.

In response to this trend, we have incorporated

a long-stroke design in our DE-23 diesel engine for marine use, an engine which has already received wide acclaim since the first deliveries in 2011.

The superb environmental performance remains the same, while achieving space-saving and greatly increased output.

Main Specifications

Engine Type		8DEL-23		
No. of cylinders		8		
Engine speed	min ⁻¹	720	750	900
Rated output	kWm	1750	2200	
Generator output ^{*1}	kWe	1650	2080	
Bore	mm	230		
Stroke	mm	350		
Piston speed	m/s	8.4	8.8	10.5
Brake mean effective pressure	MPa	2.51	2.41	2.52
Length	mm	7390		
Width	mm	1970		
Height	mm	2860		
Dry weight	kg	30000		

^{*1} Generator efficiency calculated at 94.5%.

^{*2} The dry weight and external dimensions vary depending on the generator specifications and accessories.



Dimensional Drawings (Compared with the 6DK-28e)

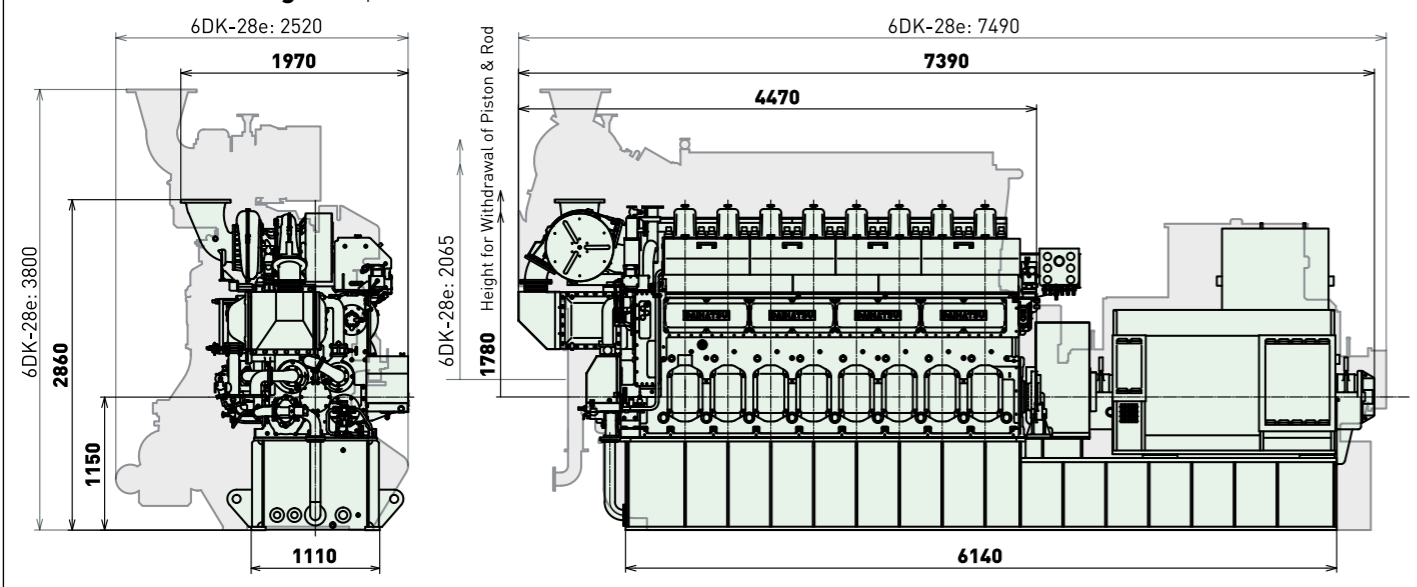

DAIHATSU

DAIHATSU DIESEL MFG. CO., LTD.

2-10, Nihonbashi-Honcho 2-chome, Chuo-ku, Tokyo, 103-0023, Japan
 Tel: +81-3-3279-0821 Fax: +81-3-3245-0395
 E-mail: shinsuke.okajima@dhtd.co.jp

FURUNO

Keep Steady at Sea

-New Radar FAR-2xx8 series from Radar Expert, FURUNO-

MAIN FEATURES of the FAR-2xx8 Series

- Automatic Clutter Elimination (ACE) for unprecedented echo clarity
- Fast Target Tracking™ (TT) function to prevent collision at an early stage
- InstantAccess bar™ for immediate access to the functions you need
- Well-designed controllers for stress-free operation
- Solid State Radar model - NXT - specialized in target detection and maintainability (S-band only)
- Target Analyzer™ function and Chart layer for the better understanding of your surroundings (Non-IMO only)



Quality, comfortable interface, and smart design come together



1959 First radar, FR-301

HISTORY of FURUNO RADAR

Since 1959, FURUNO has been dedicating the best of our expertise and technological knowledge to the development of reliable and efficient radar for the safe voyage of the vessels. In 1974, we received from NMEA (National Marine Electronics Association) the Best Manufacturer Award in marine radar category. With a rich experience in the maritime industry and a clear vision for the future of marine travel, we keep on creating new generations' ship operation experiences.

INTERVIEW: MAKING NEW HISTORY- the NEW RADAR FAR-2xx8 series

"We wanted to create simply the most long-lasting radar which could be fully utilized for no less than 10 years." Said Suminori Ekuni, development project leader of the FAR-2xx8 series. He continued: The FAR-2xx8 series



Project Leader Suminori Ekuni

is a successor model of the FAR-2xx7 series. With incomparable performance, easy-to-use interface design, maintainability and robustness, in many senses the FAR-2xx8 series can be considered as a whole new class of radar. While upgrading functional aspects, we attached importance to the comfort of use and that is why the FAR-2xx8 series inherits some parts of the user interface of FAR-

2xx7 series, which many of our users are familiar with. We also added InstantAccess bar™ so that users can use short-cut functions such as ACE (Automatic Clutter Elimination) and Fast Target Tracking™ easily with just a single press of button. Safety matters as much as performance. Our latest digital signal processing technology and highly receptive antenna enables the FAR-2xx8 series to detect targets and show echoes with crisp image on your monitor, when the ships are moving fast around your vessel or even located miles away. By ensuring the performance and safety in all circumstances, we are confident that our radar will deliver the best to our customers in terms of reliability, quality, and new experience in navigation.

For more information of our new radar, visit:
http://www.furuno.com/en/merchant/radar/FAR-22x8_23x8/

FURUNO

FURUNO ELECTRIC CO., LTD.

9-52 Ashihara-cho, Nishinomiya City, Hyogo. 662-8580, Japan
 Tel: +81-798-65-2111
 URL: <https://www.furuno.co.jp/en/>

Plate Heat Exchanger with Power Generation

New solution in waste heat power generation to an Ecologically Friendly World

Structure

Plate heat exchangers (PHE) are equipment for transferring heat between hot and cold fluid through heat transfer plates. In addition to this heat exchange function, a PHE with power generation has a zone to generate electricity by temperature difference between hot and cold fluid.

The power generation zone consists of plates with thermoelectric modules and plates with spacers that form flow channels stacked alternately.

The thermoelectric module integrates multiple thermoelectric elements that generate electromotive force through Seebeck effect, while the spacers on the plates simultaneously promote heat transfer to the thermoelectric modules by increasing the turbulence in the fluids through the flow channels.

Features

1. Utilize the fluids in PHE as energy source for generating electricity.
2. Simple configuration where only the plates with thermoelectric modules and the plates

Structure and Flow diagram

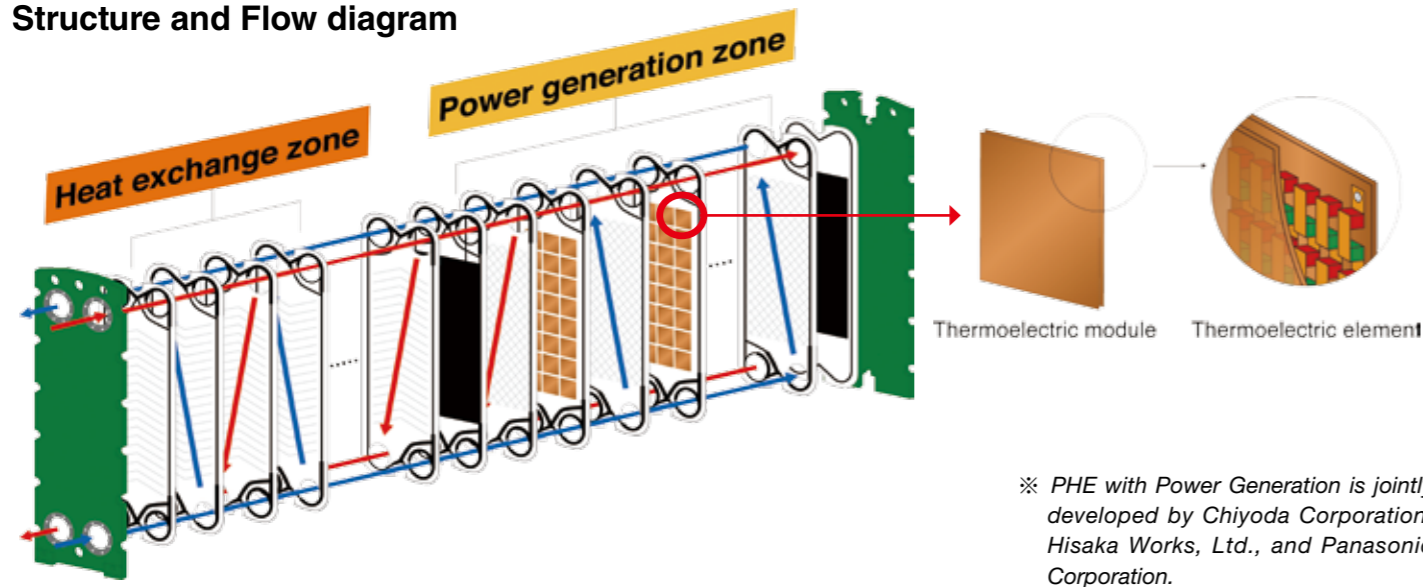

- with spacers are added to an existing PHE. No increase in PHE's footprint.
3. Easy installation due to its lightweight and compactness.

Power generation capacity

The capacity varies depending on the temperature difference between the hot and cold fluid, (ex.5W at 100°C per module). The total capacity will vary depending on the number of thermoelectric modules that are mounted on the plates.

Expected Applications

PHE with power generation can be applied to waste heat from the engine cooling system of marine vessels. By simply adding plates with thermoelectric modules to a central cooler, it is possible to obtain electricity that can contribute to the introduction of IoT to vessel engines powering electronic devices.

Smart Digital Tuner Worldwide (KST-1000-W)

Product overview

Kyokuyo Electric Co., Ltd., a firm handling electrical equipment for marine vessels, has developed the Smart Digital Tuner Worldwide (KST-1000-W), a TV tuner supporting terrestrial digital broadcasts systems all over the world.

Smart Digital Tuner Worldwide enables viewing of terrestrial digital broadcasts, on ships in port or navigating along a coastline, simply by connecting it for ships to an existing TV and antenna.

Setup operation is simple, and no major work is necessary to install the equipment.

Background

In the field of terrestrial TV broadcasting, a worldwide shift is underway from analog broadcasting to digital broadcasting, but broadcasting standards for terrestrial digital broadcasting are not uniform throughout the world, and the various standards include the Japanese system (ISDB-T), Brazilian system (ISDB-TB), European system (DVB-T), second generation European system (DVB-T2), American system (ATSC), and Chinese system (DTMB). Therefore, in order to view terrestrial TV on ships traveling to various countries throughout the world, it has been necessary to prepare receivers (TVs or tuners) compatible with the different terrestrial digital broadcasting standards at each port of call. In addition, even if TVs or tuners compatible with the standards of each country are prepared, troublesome procedures have been necessary when viewing with a single TV, such as preparing multiple devices and switching the wiring each time.

To enable ship-owners to improve entertainment equipment and reduce the burden on ship crew under

these conditions, Kyokuyo Electric has **developed a terrestrial digital tuner enabling reception of all terrestrial digital broadcasting standards with a single device**

Main features

1: Compatible with terrestrial digital broadcasting standards worldwide

This system enables TV viewing while in coastal regions (or in port) in each country.

- ISDB-T: Japan
- ISDB-TB: South America etc.
- DVB-T: Europe, Australia, Taiwan etc.
- DVB-T2: UK etc.
- ATSC: North America, Korea etc.
- DTMB: China etc.

2: Intuitive, simple operation

Operation relating to TV viewing, such as region selection (broadcasting system selection) and channel scan, can be done simply and easily. Menu screens and the operation manual are provided in both Japanese and English.

3: Can be connected with analog worldwide TV using through-out output

The main unit is equipped with an antenna through-out output terminal for connecting an analog worldwide TV, to enable viewing of analog TV in countries continuing to broadcast terrestrial analog TV.





Fuel Gas Supply System for ME-GI Engines / High Pressure Pump

A high pressure pump and a high pressure gas compressor are generally used for LNG carriers propelled by ME-GI engine. (Fig.1) Therefore, Mitsui E&S Machinery Co., Ltd. (MES-M) developed a high pressure reciprocating pump (HP pump) using a hydraulic drive system for fuel gas supply systems (FGSS) used on LNG vessels. (Fig.2) HP pump was developed in collaboration with Kaji Technology Corporation Co., Ltd, which is our subsidiary company HP pump has already been commenced sales from April, 2017.

As a distinctive feature of developed HP pump, cylinders are controlled by each motor. The adoption of this mechanism for the new pump design means that HP pump can ensure redundancy with one cylinder as a spare in addition to the cylinders for normal operation. With conventional crank-type pumps, it is necessary to have an additional complete set of pump in order to ensure redundancy because all cylinders are controlled by

one motor. Therefore, the initial cost of HP pump is lower than that of conventional crank-type pumps. Moreover, HP pump can discharge LNG flow rate in the wide range by controlling the cycle speed of HP pump with each motor. In addition, the lifetime of consumable parts in HP pump is longer than that of conventional crank-type pumps because the cycle speed of HP pump is slower than that of conventional crank-type pumps.

A performance test of HP pump using LNG at Tamano Works (MES-M) was completed in March 2017. It was confirmed that HP pump could supply stable LNG discharge pressure and flow rate to ME-GI engine. Moreover, MES can perform a combined test conducted with ME-GI engine and HP pump at our test facility. Therefore, HP pump can be provided which has completed PID setting and a response test with ME-GI engine, etc. before onboard test.

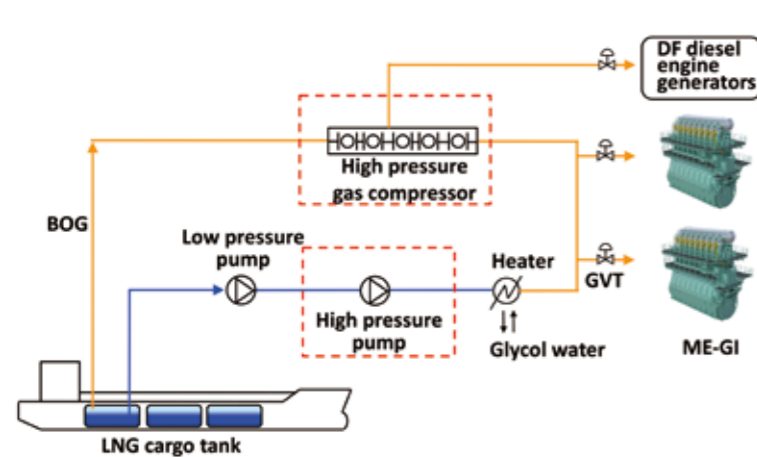

Fig.1 Schematic drawing of LNG carrier

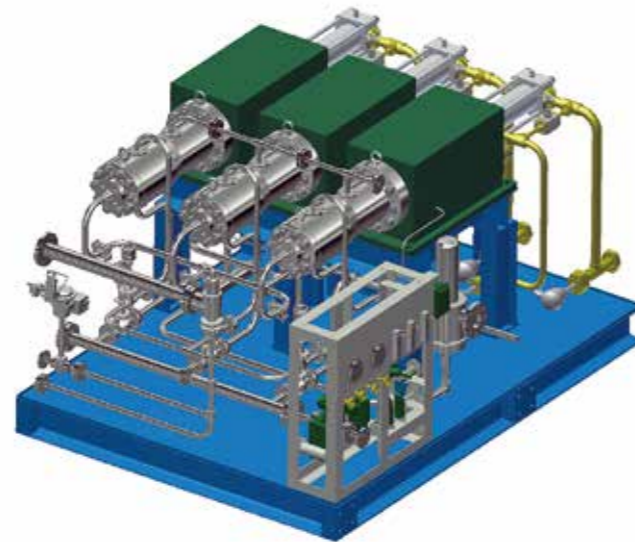

Fig.2 High pressure pump unit



MARINE CRANES ~100% Made in Japan~

For Dredging, Lifting, Piling, and Rock Breaking Works

Grab Dredger : The Largest Line Pull Capacity 160T with Omega Drive

GDT-K Series are used both as grab dredgers and large scaled marine cranes.

The dredger is equipped with an economical diesel engine of large output and an Omega Drive of large capacity, and slewing, jib luffing and the third drum are driven by hydraulic system.

It is used not only for dredging work with a grab, but also for rock breaking work, load lifting work, laying down the fish gathering blocks etc.

Attachment options: the flat dredging control system, rock breaking controlled by disk brake device, automatic braking control device for grab opening, dredging engineering control system, and more.



GDT-K Series

Hoisting Capacity From 200T to 700T Full Line Up for Multi-Purposes Work

DT-K Series are large scaled marine cranes for multi-purposes work with advanced working performance and economical benefit. The hoisting equipment of the crane is driven by an Omega Drive, and slewing, jib luffing and the third drum driven by hydraulic system.

Numbers of additional equipment such as general service hook with hook pocket, grab bucket, pile driving equipment etc. can be attached to the crane to display full power over all respects of marine construction work.



DT-K Series



Mitsui E&S Machinery Co., Ltd.

6-4, Tsukiji 5-Chome, Chuo-ku, Tokyo 104-8439, Japan
 Tel: +81-3-3544-3475 Fax: +81-3-3544-3055
 E-mail : diesel@products.mes.co.jp



SKK Corporation

1-3 YOKOHAMA-NISHIMACHI, KOCHI-CITY, JAPAN 781-0242
 Tel: +81-88-842-6262 Fax: +81-88-842-4023
 E-mail: sales@skk-crane.co.jp URL: http://www.skk-crane.co.jp/en





Mitsubishi Heavy Industries Marine Machinery & Equipment and Wartsila to collaborate on improved power and propulsion solution

Mitsubishi Heavy Industries Marine Machinery & Equipment Co., LTD (MHI-MME) and the smart technology group Wartsila have signed a Memorandum of Understanding (MOU) regarding the commercial marketing of a new energy solution for ships which combines innovative technologies from both companies to produce greater power generation capacity and higher propeller propulsion for marine vessels. Integration of MHI-MME's waste heat recovery and energy saving power generation system (WHRS) with Wartsila's operational control technology for shaft generator systems will achieve more energy efficient ship navigation and improved Energy Efficiency Design Index (EEDI).

A notable innovation is the combination of a power take off/take in (PTO/PTI) shaft generator system with WHRS to improve the stability of the WHRS. Depending on the load of the main engine and the ship's network, the WHRS sometimes produces electrical energy in excess of that needed by the network. Such energy can be utilised via the PTO/PTI generator to drive the propeller shaft. The surplus energy can be used to assist the ship's drive under full load by direct application to the propeller shaft. The WHRS can be operated in parallel with a diesel generator set under low main engine load. Parallel operation with a shaft generator via PTO operation is

also easily implemented. The patented design connects the WHRS generator into the DC link circuit of the PTO/PTI shaft generator rather than directly into the main circuits. This allows operation of the WHRS at reduced speed to create higher efficiency of the turbine system under part load. This avoids the necessity of speed regulation valves, which cause throttle or bypass losses. MHI-MME has various energy saving technologies which are all adaptable for this new solution. One example is integration with MHI-MME's power turbine generator which enables supply of electricity across a range from approximately 500 to 2,000 kilowatts (kW), driven by gas extract-ed from a 2-stroke main engine, via the PTO/PTI generator.

MHI-MME's solutions have previously consisted of waste heat recovery systems and Organic Rankin Cycle (ORC) systems, which are small-scale binary power generation systems that efficiently recover and use extremely low-temperature heat sources. These applications have pri-marily focused on large container ships. Now, with addition of the latest solution, MHI-MME will offer an even wider array of energysaving solutions for ships that have conventionally employed shaft generators, to help them comply with the more stringent environmental regulations to go into effect in the near future.

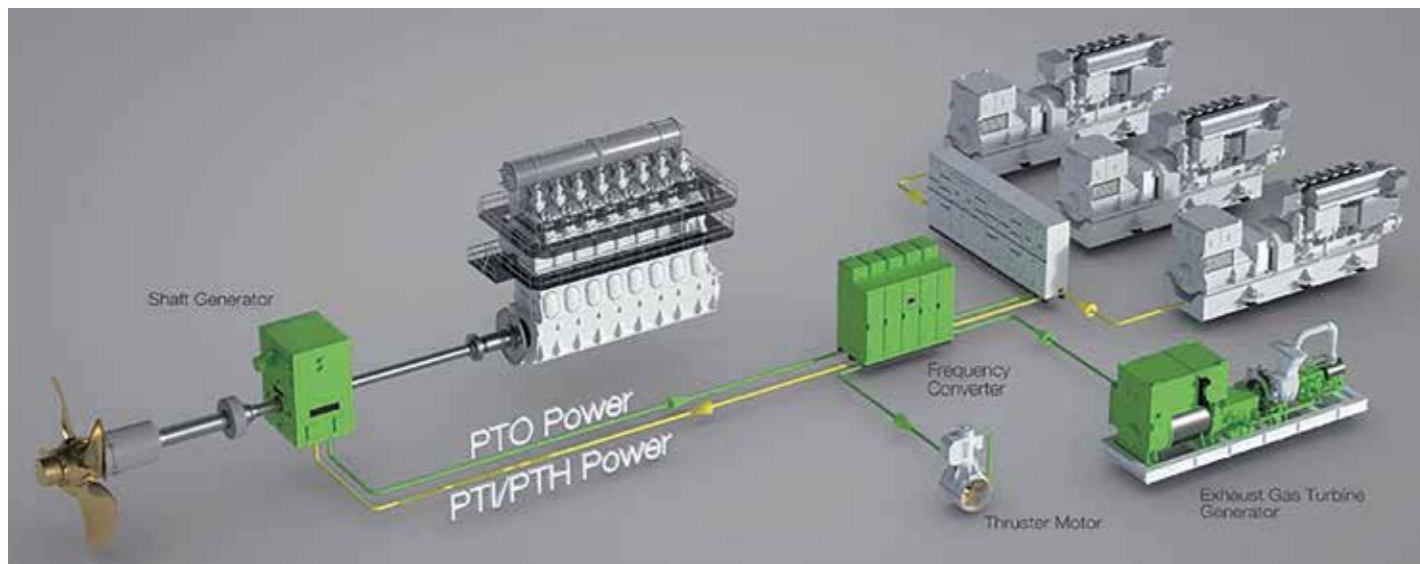

Configuration image



Mitsubishi Heavy Industries Marine Machinery & Equipment Co., Ltd.

16-5 Konan 2-Chome, Minato-ku, Tokyo 108-0075, Japan
Tel: +81-3-6716-5331
E-mail: info_meet@mhi-mme.com



An ABB and IHI joint venture

FiTS2

FiTS2, a new technology development by ABB Turbocharging, brings to the marine industry unique levels of fuel savings and flexibility.

FiTS2 stands for "Flexible integrated Turbocharging System for 2-Stroke Engines". With FiTS2, operators of large marine applications running two-stroke engines can benefit from maximum fuel savings at part and low load, while maintaining highest flexibility to go to full output immediately.

FiTS2 denotes a complete, integrated turbocharging system that consists of sequential turbochargers of different specifications and wide compressor maps. As the name suggests, two or more turbochargers operate in sequence with complementary air delivery at different engine loads. The turbochargers are controlled by specially developed FiTS2 tuning software, combined with dedicated, flow optimized valves that can operate under full load.



Learn more about FiTS2:

FiTS2 – The sequential turbocharging solution for fuel savings and flexibility

Benefits

- A significant fuel reduction of up to 6gr/kWhr in part and low load
- Keeping full flexibility over entire engine load by means of automatic valve switching under load
- Additional savings: Slow steaming without an auxiliary blower. Switch-off point already at ~25% load (instead of 35% load).

Setup

- Integrated solution with the engine through special tuning, and with automated full sequential turbocharging
- Smaller and bigger turbochargers, instead of just one big or two same-sized turbochargers (or 2+1 turbochargers for large engines)
- One turbocharger able to have automated "switch-off" during part load
- Optimized engine settings for FiTS2 by means of special tuning of the engine.

Additional features

- Engine complies fully with NOx Tier II Requirements (IMO-III solutions additionally possible).

Turbo Systems United Co., Ltd. (TSU) is a joint venture of ABB K.K. and IHI Corporation (IHI). TSU is committed to provide ABB and IHI turbocharger products to engine builders and end-users in Japan and Taiwan with best quality, as well as first class service and expertise.



An ABB and IHI joint venture

Turbo Systems United Co., Ltd.

ThinkPark Tower 22F 2-1-1 Osaki, Shinagawa-ku, Tokyo 141-6022
Tel: +81-3-4523-6900 Fax: +81-3-4523-6990
E-mail: tsu_general@turbo.co.jp URL: http://www.turbo.co.jp/doc/eng/



over 37 years HISTORY on LNG fueled products delivery records for over 180 vessels

Solution for keeping Blue Sky

Since the regulation for environment on exhaust (eg:IMO Tier-3) is becoming strictly, utilizing LNG is focused as a solution for environmental conservation.

Using LNG as a vessel's fuel is effective for reducing NOx/SOx/CO2. CH4, which is main component of BOG, is 25 times more potent than CO2 for global warming, so we think reducing CH4 emission into the atmosphere is effective for preventing global warming. To reduce CH4 emission, our combustion technology makes it possible to process CH4 without emitting into the atmosphere.

Advantage of Gas/Oil 'Simultaneous Mixed Combustion'

A burner just switching Gas/Oil burners, which is Gas/Oil Single-fuel combustion burners, cannot process BOG containing much N2 and Inert Gas

when bunkering and docking.

All of VOLCANO's DF burners can combust Gas and Oil simultaneously : 'Simultaneous Mixed Combustion' can process BOG containing much N2 and Inert Gas, therefore Boiler/Burner could be used as a GCU. 'Simultaneous Mixed Combustion' can help saving energy and reducing the environmental load because the Boilers which installing our DF burners could use BOG as fuel of Boiler/Burner.

Strength of VOLCANO

VOLCANO has over 37 years' experiences and history for Gas/Oil 'Simultaneous Mixed Combustion' Installing boiler burners and small Gas Combustion Units in approximately more than 180 LNG carriers or LNG fueled vessels.

We research and develop technology for various Fuel combustion with 'Full Scale Combustion Test Facilities'.



SFFG II



Vignis-mini



Gas Valve Unit



VOLCANO CO., LTD.

1-3-38, Nonakakita, Yodogawaku, Osaka 532-0034 Japan
Tel: +81-6-6392-5541 Fax: +81-6-6396-7609
E-mail: info-m@volcano.co.jp

JSMEA seminar schedule in FY2018

Japan Ship Machinery and Equipment Association (JSMEA) holds seminars around the world every year to introduce Japan's latest ship machinery and equipment products and technologies.

Joined by some 20 Japanese manufacturers, our seminars consistently attract around 200 attendees. Compatriot enterprises and parties engaged in local maritime affairs deliver presentations, while receptions

allow participants to engage in productive interchanges. Thanks to these and other activities, all of our seminars are highly rated.

In fiscal 2018, we will travel to the United Arab Emirates (UAE), Taiwan and Malaysia. We strongly urge you to join us at the seminars that we will organize in these economies, bringing you many ship machinery and equipment makers from Japan.

UAE: ship machinery/equipment seminar

Date : October 31, 2018

Place: Exhibition Hall (Halls 6-8), Seatrade Maritime Middle East
Dubai World Trade Center (address: Sheikh Zayed Road, Dubai, UAE)

Taiwan: ship machinery/equipment seminar

Date : November 27, 2018

Place: Regent Taipei (address: No. 3, Lane 39, Section 2, Zhongshan N. Road, Taipei 104, Taiwan)



Japanese ship machinery & equipment seminar in Taiwan. Nov,2016

Malaysia: ship machinery/equipment seminar

Date : February 28, 2019

Place: To be announced



Malaysia-Japan Business matching forum. Feb,2016

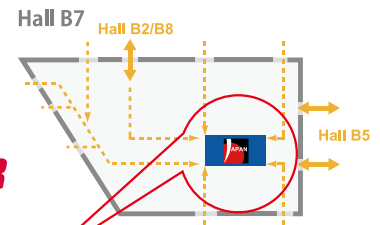

B7-438 Daihatsu Diesel Mfg. Co. Ltd.	B7-444 BEMAC - Uzushio Electric Co., Ltd.	B7-450 IBUKI KOGYO CO., LTD.	B7-452 Kawasaki Heavy Industries, Ltd.	B7-454.1 Mitsubishi Kakoki Kaisha Ltd.
B7-422.1 Musasino Co., Ltd.	B7-442 NABTESCO CORPORATION	B7-446 Nitto Chemical Industry Co., Ltd.	B7-448 SHINKO IND. LTD.	B7-454 Riken Corporation
B7-529 Yanmar Co., Ltd.	B7-529.1 NANIWA PUMP MFG. CO., LTD.	B7-537 MOL Techno-Trade, LTD.	B7-539 Sunflame Co., Ltd.	B7-454.2 NICO Precision Co., Inc.
B7-531 Taiyo Electric Co., LTD.	B7-440 JSMEA Information	B7-533 Fuji Electric Co. Ltd.	B7-535 NISHISHIBA ELECTRIC CO. LTD.	B7-543 Japan Engine Corporation

Stand number	Company Name
B7-444	BEMAC-UZUSHIO ELECTRIC CO., LTD.
B7-438	Daihatsu Diesel Mfg. Co., Ltd.
B7-533	Fuji Electric Co., Ltd.
B7-541	Fuji Trading Co., Ltd.
B7-450	IBUKI KOGYO CO., LTD.
B7-543	Japan Engine Corporation
B7-440	Japan Ship Machinery and Equipment Association
B7-452	Kawasaki Heavy Industries, Ltd.
B7-454.1	Mitsubishi Kakoki Kaisha, Ltd.
B7-537	MOL Techno-Trade, Ltd.
B7-442.1	Musasino Co., Ltd.
B7-442	NABTESCO CORPORATION
B7-529.1	NANIWA PUMP MFG. CO., LTD.
B7-454.2	NICO Precision Co., Inc.
B7-535	NISHISHIBA ELECTRIC CO., LTD.
B7-446	NITTO CHEMICAL INDUSTRY CO., LTD.
B7-454	Riken Corporation
B7-448	SHINKO IND. LTD.
B7-539	Sunflame Co., Ltd.
B7-531	Taiyo Electric Co., LTD.
B7-529	Yanmar Co., Ltd.



Head Office:

Toranomon Toyo Kyodo Building, 13-3, Toranomon 1-chome, Minato-ku, Tokyo 105-0001, Japan
Tel: +81-3-3502-2041 Fax: +81-3-3591-2206 E-mail: info@jsmea.or.jp URL: http://www.jsmea.or.jp

Overseas Offices:

JETRO Hongkong, Ship Machinery Department

Room 4001, 40/F., Hopewell Centre, 183 Queen's Road East, Wan Chai, Hong Kong, China
Tel: +852-2501-7291 Fax: +852-2868-1455

JETRO Houston, Offshore and Maritime Department (from April)

1221 McKinney, LyondellBasell Tower, Suite 4141, Houston, Texas 77010, U.S.A.
Tel: +1-713-759-9595 Fax: 1-713-759-9210

JETRO Singapore, Ship Machinery Division

Hong Leong Building, #38-01 to 05 #37-02A 16 Eaffles Quay, Singapore 048581
Tel: +65-6429-9522 Fax: +65-6224-1169